

SHS-H705

USER MANUAL

Samsung SDS Digital Door Lock

Convenient Opening

- User friendly access with fingerprints and password

Graphic Interface

- Shows the operation status of the doorlock

Double Authorization

- Requires fingerprint & password combination to open

Double Locking

- Prevents opening from outside (Do not disturb)

Built-in Fire Detection

- Generates alarm in case of a fire

Security Function

- Prevents intrusion from the outside

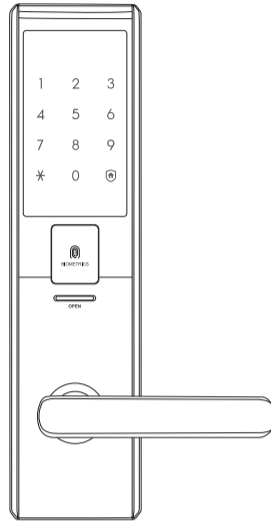

www.samsungsds-nss.com/en

GC68-02067B ED-01

Safety Cautions

Warning This section contains important information to ensure the user's safety and prevent potential damage to property. Please, read this section carefully and use the product accordingly.

- The user shall not install or repair the product without authorization.
- Do not install the product in the place where the gap between the door and the frame is 5mm or more.
- Make sure that no unauthorized person has the access to the password.
- Do not operate the product with wet hands, and keep liquids such as water or drinks away from the product, or the product may malfunction or be damaged.
- Do not use the excessive force or sharp objects to push the lockbuttons, as this can damage the product.
- Make sure that the door is completely closed when going outside. The manufacturer does not assume the responsibility for any harm caused by engagement of the lock on an improperly closed door.
- Please do not hang on the product or pull it.
- Be sure to correctly match the poles (+/-) when installing the batteries. Install the batteries with the correct poles (+/-).
- Long-term exposure to direct sunlight may cause a crack on its touch pad. Avoid exposure to direct sunlight during installation.
- During battery replacement, use a new one instead of the existing battery.
- Do not use water, benzene or alcohol when cleaning the product, as these fluids can cause product malfunction.
- Replace the batteries within 1 week after the battery replacement alarm sounds.

Product Components

The product components used may vary depending on the installation environment.

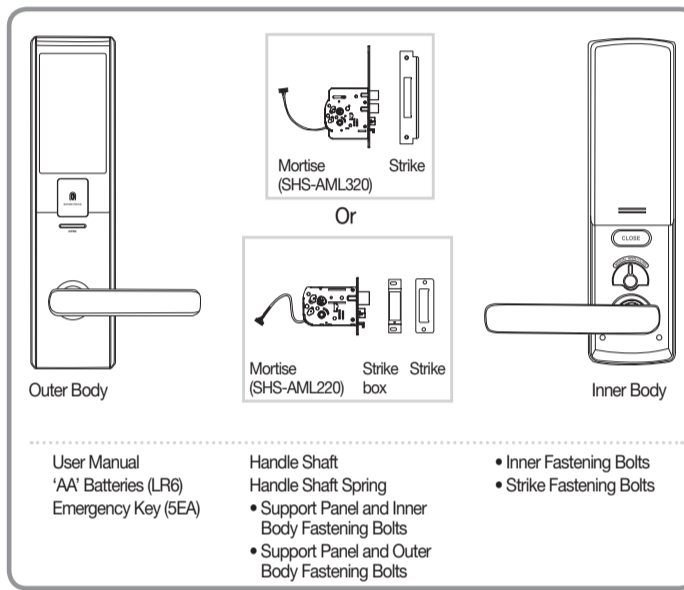

Outer Body Parts

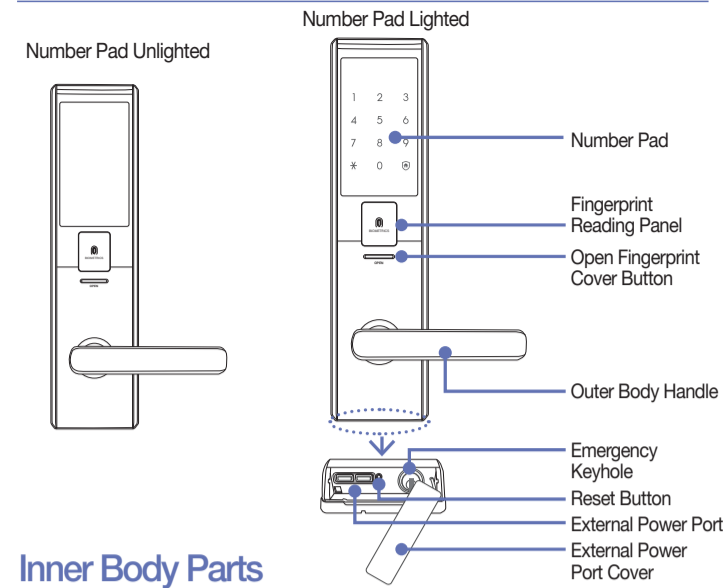

Inner Body Parts

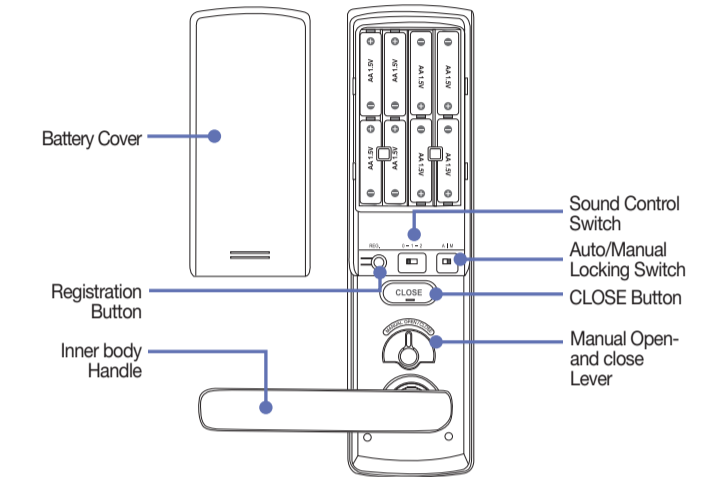

Mortise

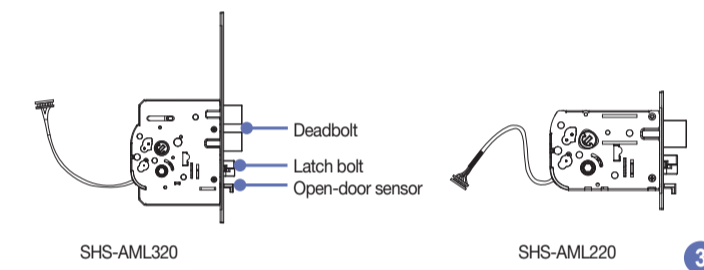

Main Menu

To setup door lock function, go to main menu.

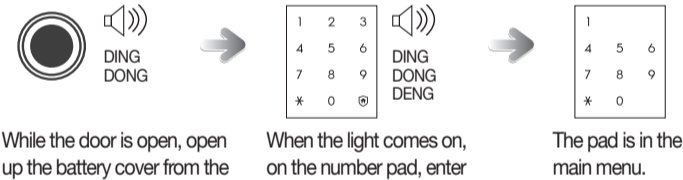

Summary of How to Select Modes

1. Enter the main menu.
2. Press menu code, then press [*] button.
3. Select the function you want and press [*] button.

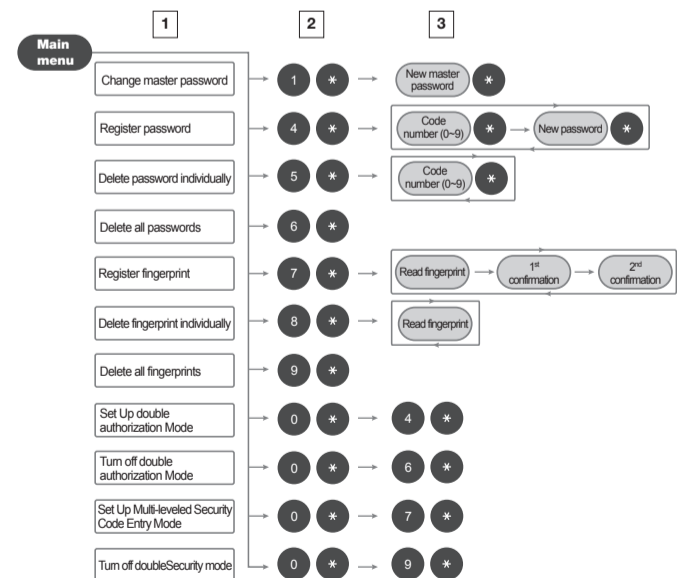

Opening the Door from Outside with a Password

When purchased, the product is set to Multi-level Security Code Entry Mode initially. Please refer to "How to Set Up Multi-level Security Code Entry Mode" for Common Mode setting.

1. Multi-level Security Code Entry Mode

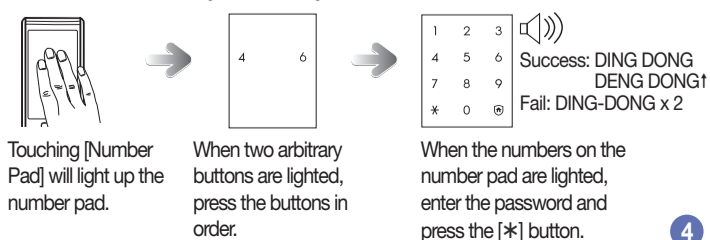

2. Common Mode

If the security mode is changed as 'common mode', second step will be skipped.

Note

- Password must be entered after the light is on, and if does not, touch [Number Pad] and re-enter.
- To cancel, press [⊕] button and re-enter.
- If the password is wrong 5 times, "peep" warning alarm will sound 20 times and the system will shut-down for about 3 minutes. When malfunction happens, "beep" will sound every 10 seconds, and stop mode will be turned off automatically after 3 minutes with multiple 'beeps'.

Opening the Door from the Outside with a Fingerprint

Use fingerprint to open the door from the outside. While the LED light is on, place the finger with the registered fingerprint in the correct way.

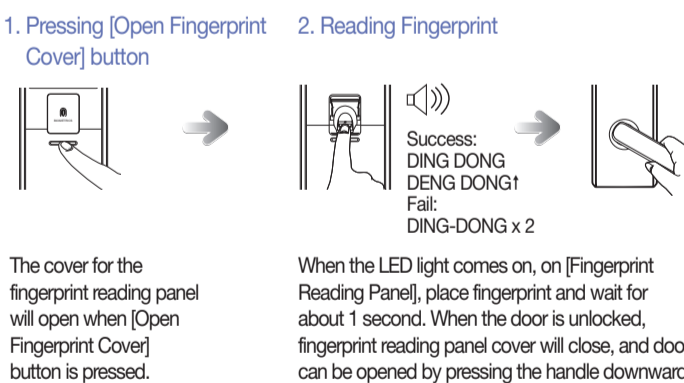

Opening the Door from the Inside

- Pulling down the Door Lock Handle
- Rotating the Manual Open/Close Lever to the Right or Left

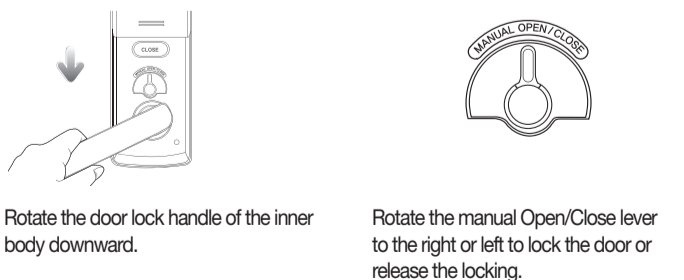

Closing the Door from the Outside

- Touch [Number Pad]
 - Press [Open Fingerprint Cover] button
- If you go outside while in manual locking mode, touch [Number Pad] on the outer body.
- If you go outside while in manual locking mode, touch [Open Fingerprint Cover] on the outer body.

Closing the Door from the Inside

- Automatic Locking Setting**: The door is automatically locked 2 seconds after the door is closed.
- Manual Locking Setting**: The door is locked when the [Close] button is pressed.

Initialization (master password, password, fingerprint)

Delete all data. When data is being Initialization, new master password will be '1234' and previously registered fingerprints and password will be deleted.

1. Pressing the [Register] Button (from the inside)
2. Entering the Numbers for Initialization (from the outside)

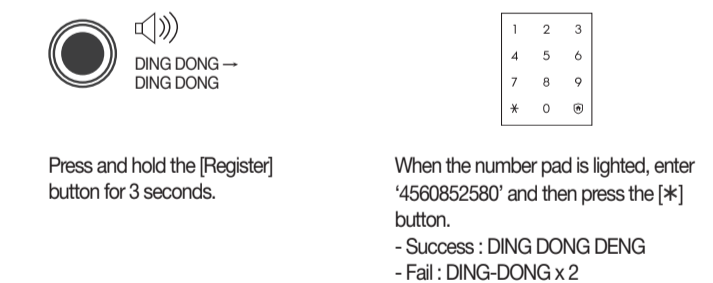

How to Change Master Password

Master password must be 4-12 digits long, and only one can be designated as the master password.

1. Entering the main menu (refer to page 4)
2. Selecting change master password menu
3. Entering new master password

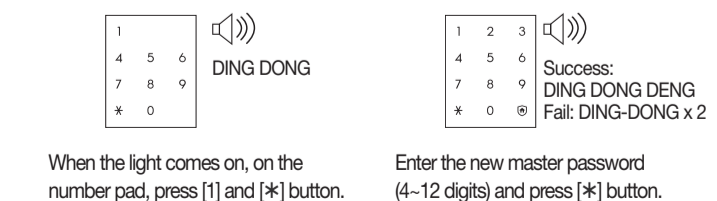

Note

- Registered master password cannot be deleted, and can only be changed with new password or Initialization of everything (master password, password, fingerprints) and re-registration.

How to Register Password

Password must be 4-12 digits long and there can be up to 10 passwords.

1. Entering the main menu (refer to page 4)

2. Selecting register password menu

When the light comes on, on the number pad, press [4] and [*] button.

3. Entering code number

4. Entering password



When the light comes on the numbers not yet registered, press the desired code number (0-9) and then [*] button - Already registered numbers cannot be shown.

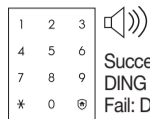

When the light comes on, on the number pad, enter the new password (4-12 digits).

Warning

- To prevent theft, it is highly recommended to use a password with more than 6 digits. (Only numbers from 0 to 9 can be used.)
- When the new password is being entered, the same number as the old password or default password cannot be used any more.
- Do not let others know the password. Change it periodically to prevent break-in.

How to Delete Password

Registered passwords can be deleted individually or all at once.

1. Entering the main menu (refer to page 4)

[Individual delete]

2. Selecting delete individual password menu

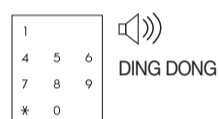

When the light comes on, on the number pad, press [5] and [*] button.

3. Entering code number to be deleted



When the light on the code number that you wish to delete comes on, press it and then press [*] button.

[Delete all]

2. Selecting the delete all password menu



When the light comes on, on the number pad, press [6] and [*] button.

- To open the door when all passwords are deleted, use master password or fingerprint.

7

How to Register Fingerprint

Up to 100 fingerprints can be registered for use.

1. Entering the main menu (refer to page 4)

2. Selecting register fingerprint menu

When the light comes on, on the number pad, press [7] and [*] button.

3. Reading the fingerprint to be registered



After the bell, the cover will open. When the light comes on, place finger on the fingerprint reading panel until 'PEEP' sound rings.

When the light comes on, check if the fingerprint is read correctly, place finger on the panel again until the 'DING DONG DENG' sound rings.

4. Registration completed



To complete the registration, press [*] button or [Open Fingerprint Cover] to close the cover.

5. Fingerprint registration confirmation

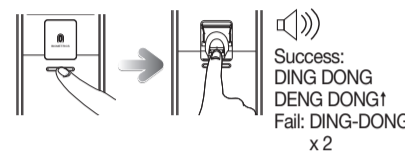

Press [Open Fingerprint Cover] button to open the cover and place finger on the fingerprint reading panel.

- To register multiple fingerprints, after the first fingerprint, place others within 20 seconds. When registering fingerprints continuously, if the finger is not in place within 20 seconds, the cover will close down automatically, finishing the session.

How to Delete Fingerprint

Registered fingerprints can be deleted individually or all at once.

1. Entering the main menu (refer to page 4)

[Individual delete]

2. Selecting delete individual fingerprint menu



When the light comes on, on the number pad, press [8] and [*] button.

3. Reading the fingerprint that will be deleted



When the cover opens and light comes on, place fingerprint that you wish to delete.

[Delete all]

2. Selecting the delete all fingerprint menu

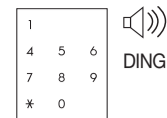

When the light comes on, on the number pad, press [9] and [*] button.



- To open the door from the outside when all fingerprints are deleted, use emergency key or registered password.

How to Set Up Multi-leveled Security Code Entry Mode

You can set the security mode suitable for your use when you open the door using a password.

1. Entering the main menu (refer to page 4)

2. Selecting register password menu

When the light comes on, on the number pad, press [0] and [*] button.

3. Selecting mode



[7]: Multi-leveled Security Code Entry Mode
[9]: Common Mode

After pressing button [7] or [9], pressing [*] will turn on or off the security mode.

How to Set Up Double Authorization Mode

Double authorization mode requires both fingerprint and password to open the door, ensuring more security. You can either set up or cancel the function for your convenience.

1. Entering the main menu (refer to page 4)

2. Selecting register password menu

When the light comes on, on the number pad, press [0] and [*] button.

3. Selecting mode



[4]: double authorization mode on
[6]: double authorization mode off

After pressing button [4] or [6], pressing [*] will turn on or off the authorization mode.

[Turn on double authorization mode]

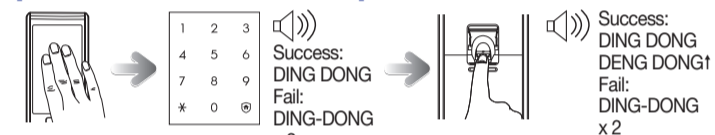

Touch [NumberPad]. When the light comes on, on the number pad, enter the password and press [*] button. When the [Fingerprint Reading Panel] lights up, it will read the fingerprint. When the authorization is success, the door will open.



- To setup the double authorization mode, more than 1 fingerprint must be registered.
- Double authorization mode will automatically be turned off when all fingerprints are deleted.

9

Setting the Security Function

Setting the Security Function

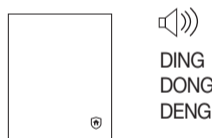

1. When the door is closed [Ⓜ] of the outside body's number pad will light up.
2. Press and hold the [Ⓜ] button on the outer body for 3 seconds while the door is locked.

Releasing the Security Function

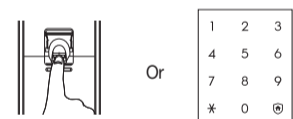

After placing registered fingerprint or entering password, press [*] button.

- The security function will automatically shut off if a registered password or fingerprint is entered.

7

Setting the Double Locking

The double locking function prevents opening of a locked door from outside.

Setting Double Locking

Releasing Double Locking



Press the [Close] button for 2 seconds or longer from the inside while the door is locked.

The double locking function is released when the inner body handle is rotated downward, or the manual Open/Close lever is rotated to the right or left.

Activating Double Locking

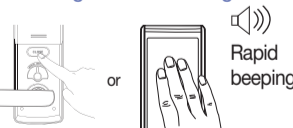

Inside : The double locking sound is generated when the [Close] button is pressed.
Outside : Touch [Number Pad] or press [Open Fingerprint Cover] will ring the double lock bell, LED for double lock at the bottom-left of number pad will turn on, and door will not be opened.

- Please be cautious when using this function, since the door can only be opened from the outside using the emergency key when this function is set. Please be particularly careful of children accidentally setting this function from the inside.

Automatic/Manual Locking Setting

The Automatic Locking mode allows for automatic locking of the door when it is closed.



Set the [Automatic/Manual Locking] toggle switch of the Inner Body to the 'A/M' position.

- Automatic: The door is automatically locked 2 seconds after being closed.
- Manual: The door does not lock automatically, and [CLOSE] button must be pressed from the inside, touch [Number Pad], or touch [Open Fingerprint Cover] -lock button to close the door.

10

Sound Setting and Releasing

The sound that is generated when the number buttons are pressed, when the door is locked or when the locked door is unlocked, can be set according to the user's preference. The product is set to generate all sounds at the factory.



Open the battery cover on the inner body.

Put the [Sound Control] switch on one of [0], [1], or [2], and close the battery cover.

- [0] Button: All sounds except the alarm sound are deactivated.
- [1] and [2] Buttons: All sounds are activated and the sounds get bigger as the step become higher.

Replacing the Batteries

Battery Replacement Alarm Generation

If the melody "Blues for Elise" rings before the door opens, it is time to replace batteries (The Low battery indicator at the bottom of the number pad will light up).

Replacing the Battery

Replace all batteries within a week from the first alarm sound.



- If the batteries are not inserted in the right way, the door lock will not work.
- Leakage from the battery may harm the product, so please check the battery regularly (about once every six months).
- Until the batteries are replaced after the low battery ring tone, functions like register, change, or Initialization of password/fingerprint cannot be used.
- The product may shut down without warning if the batteries are not replaced promptly after the low battery ring tone.

Using the Emergency Battery

If the batteries are not replaced after their replacement time comes, they will be completely discharged and the lock will not operate.

- Purchase an emergency battery (9V) at the nearest store.
- As the alkaline batteries offer longer life, they are recommended over the manganese batteries or rechargeable ones.

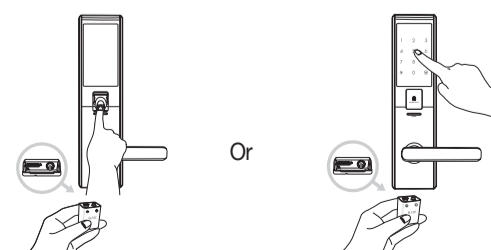

Remove the cover of the external power port, place 9 volt battery (emergency battery) at the connection point, and then place finger on the fingerprint reading panel.

11

Alarm Sound (Prank Prevention Function)

This function generates an alarm sound and deactivates lock operation when it is improperly handled from the outside.

When trying to open the door with fingerprint that is not registered or an incorrect password 5 times. After the warning bell, door lock will not work for 3 minutes. When malfunction happens, "beep" will sound in every 10 seconds, and stop mode will be turned off automatically after 3 minutes with multiple 'beeps'.

Releasing the Alarm

Inside Press the [Register] button.

Outside After placing registered fingerprint or enter password, press [*] button.

Intrusion Detection Function

This function generates the alarm sound when an attempt is made to forcefully open the door from the inside or the outside. (This is a basic function of the lock, and cannot be separately set or released.)

Built-in Fire Detection Function

This function generates the alarm sound when fire is detected so that the residence can quickly respond. The built-in fire detection function is a basic function of the lock, and cannot be released by the user.

When fire occurs, the temperature sensor detects it and flashes the [Close] button while generating the alarm sound. The door is automatically opened after the alarm sound has stopped. (The lock resumes normal operation if the inside temperature returns to a normal level.) The built-in fire detection function is activated when the temperature rises around 70°C, which may differ depending on the installation environment.

Product Specifications

Item	Specifications	
Voltage	8EA of 1.5V AA Alkaline Batteries(LR6) (6V)	
Emergency Power Source	9V Battery (6LF22) (Separately sold)	
Operation Method	Electronic Control Method (Password entry or card or key tag reading)	
Weight	2.6Kg (including both inner and outer bodies)	
Product Dimensions	Outer Body (including the handle)	81.3 mm(W) x 318 mm(H) x 75 mm(D)
	Inner Body (including the handle)	79.0 mm(W) x 290.0 mm(H) x 80.3 mm(D)

- The contents of this user guide are subject to change without prior notice to the user in order to enhance performance of the product.

12